

Sightglass light fittings

Series KLR in stainless steel for use in safe areas



Sightglass light fitting type KLR 50 HSch, 50 W, 24 V, mounted with tilting hinge "Sch" on sightglass to DIN 28120, DN 100, PN 10, for application "view and light through one assembly".



Sightglass light fitting type KLR 100 HD R80 K2, 100 W, 24 V, with built-in momentary push-button "D", mounted with flange collar "R 80" on screwed sightglass similar to DIN 11851, DN 80, PN 6.

The sightglass light fittings of the series KLR represent a further stainless steel version of the well-known miniLUX® luminaires. They offer the following main features and advantages:

- Very interesting prices due to high series production.
- 50 W version suitable for continuous use.
- **Easiest mounting** by means of a tilting hinge "Sch"/"Sch 1" or a flange collar "R".
- **Up to 20 W power available with integrated transformer.**
- **Brilliant and dazzle free illumination**, even of difficult media.
- **Small dimensions providing high lighting power.**
- Quick change of bulbs **without** necessity to demount the bolted-on luminaire!
- For use in version "view and light through one assembly" as well as for the two port system.

Application:

On sightglasses to DIN 28120 **from DN 40**
 On sightglasses to DIN 28121 **from DN 40**
 On screwed sightglasses similar to DIN 11851 **from DN 65**
 On pipeline flow indicators (in-line sightglasses)

Operating conditions:

Independent of internal vessel pressure or vacuum.

Construction:

Housing and fixation elements in **stainless steel**. Cable gland Pg 9, vertical. On request with rectangular cable gland ("K2"). Built-in reflector. Bulb socket for halogen bulbs of 5, 10, 20, 50 or 100 Watts. Built-in push-button for momentary operation "D" (types KLR 05 / 10 / 50 also available **without**, on request). Glass disc resistant against high temperatures. Gaskets resistant against corrosion and alteration.

Electrical data:

Supply: AC or DC (depending on type)
 Terminal voltage: Refer to table below
 Power: 5, 10, 20, 50 or 100 W (depending on type)
 Maximum current: 4,2 A

Transformers with 24 V secondary voltage in open design (IP 00) for mounting into control panels or switch boards as well as in closed version (IP 65) may be supplied for different primary voltages and power capacities.

Bulb sockets:

Nominal rating 5 / 10 / 20 W: 2 pins socket G4
 Nominal rating 50 / 100 W: 2 pins socket GY 6.35

Enclosure protection degree:

IP 65, dust and spray water tight.

Admitted for use in food processing industries.

Survey on standard types:

Type	KLR 05 HD*	KLR 10 HD*	KLR 20 HD	KLR 50 HD*	KLR 100 HD
Nominal rating	5 W	10 W	20 W	50 W	100 W
Terminal voltage	36 / 42 / 115 / 240 V (AC)			12/24V (AC/DC)	24 V (AC/DC)
Bulb	Halogen	Halogen	Halogen	Halogen	Halogen
Weight**	0,90 kg	0,90 kg	0,90 kg	0,55 kg	0,55 kg

* For the version **without** push-button, the correct type designation omits the "D".

** Including the fixation tilting hinge "Sch"/"Sch 1". (With fixation "R" depending on size).

Mounting:

The luminaire is normally mounted by means of its fixation elements, suitably slotted to take a fixing bolt M6. This bolt fits a drilled and tapped hole in the cover flange of a sightglass to DIN 28120/28121 or similar. The position of the drilled holes may be taken from the drawings on the back of this leaflet. In case of a mounting with the flange collar "R", the latter is put under the grooved collar nut of the screwed sightglass similar to DIN 11851 and then the light fitting inserted into the "R" collar and positioned by the screws delivered with the "R" fixation.

Important remarks:

Please indicate in case of order type and size (DN) of the sightglass on which the luminaire has to be mounted.

The temperature raise of the housing whilst the light fitting is in service has to be observed.

The following dimensions are valid for the types KLR 05/ 10/ 50 H(D)Sch / Sch1 / R and KLR 20/ 100 HDSch / Sch1 / R

Types KLR 05/ 10 / 50 H(D)Sch
Types KLR 20 / 100 HDSch

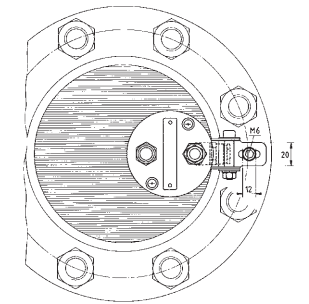
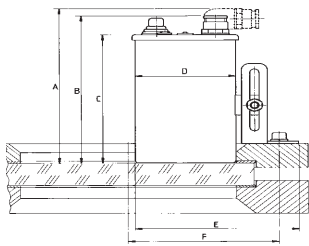

Fixation "Sch"

Types KLR 05/ 10 / 50 H(D)Sch
Types KLR 20 / 100 HDSch

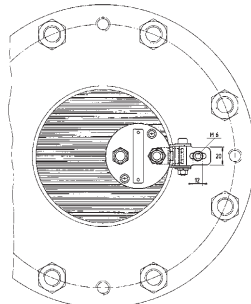
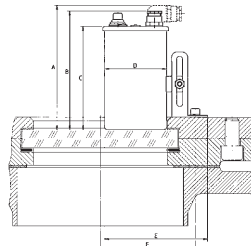

Fixation "Sch"

Types KLR 05/ 10 / 50 H(D)Sch1
Types KLR 20 / 100 HDSch1

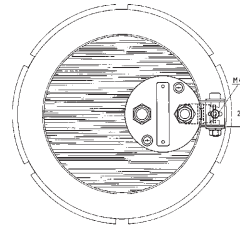
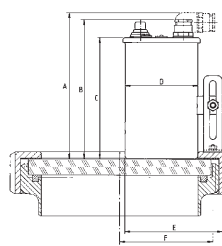

Fixation "Sch1"

Types KLR 05/ 10 / 50 H(D)R
Types KLR 20 / 100 HDR

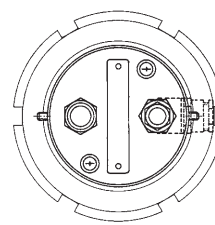
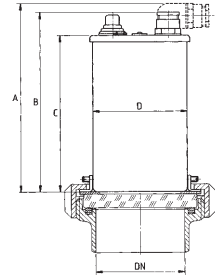

Fixation "R"

Sightglass to
DIN 28120

DN	A	B	C	D	E	F
50	141	134	117	70	115	67
80	141	134	117	70	115	77
100	141	134	117	70	115	95
125	141	134	117	70	115	108
150	141	134	117	70	115	118
200	141	134	117	70	115	142

Sightglass to
DIN 28121

DN	A	B	C	D	E	F
50	141	134	117	70	115	67
80	141	134	117	70	115	67
100	141	134	117	70	115	84
125	141	134	117	70	115	95
150	141	134	117	70	115	95
200	141	134	117	70	115	110

Screwed sightglass similar to
DIN 11851

DN	A	B	C	D	E	F
65	141	134	117	70	94	39
80	141	134	117	70	94	47
100	141	134	117	70	94	57
125	141	134	117	70	94	69
150	141	134	117	70	94	82

Screwed sightglass similar to
DIN 11851

DN	A	B	C	D
65	141	134	117	70
80	141	134	117	70
100	141	134	117	70
125	141	134	117	70
150	141	134	117	70

Branch office / exclusive agent:

Do you wish for more information about our wide range of light fittings for use in hazardous and safe areas, about our range of circular sightglasses to DIN 28120/28121, screwed sightglasses similar to DIN 11851, rectangular or D-ended sightglasses, pipeline flow indicators, centrally or sideways operated wipers, hinged sightglasses, spraying devices or our complete sight and lightglass units VETROLUX®? Are you interested in other types, special versions or different protection degrees? If yes, please contact us, our branch office or our local agents – it is our business! You will find the necessary indications about our sales network on the Internet.

All dimensions in mm. Subject to changes without preliminary notice.



MAX MÜLLER AG

PROCESS ILLUMINATION AND VISUAL OBSERVATION SYSTEMS

Hagmattstrasse 19 • CH - 4123 Allschwil / Switzerland

Telephone +41 61 487 92 92 • Telefax +41 61 487 92 99

www.maxmuellerag.com E-Mail: blt@maxmuellerag.com