

SIGHTGLASS LIGHT FITTINGS

Type L 20 deH

The ideal solution for your lighting problems in hazardous areas

- Fully developed package
- Various mounting options
- Highly competitive prices
- Interesting additional equipment
- Also supplied complete with VETROLUX[®] sightglasses

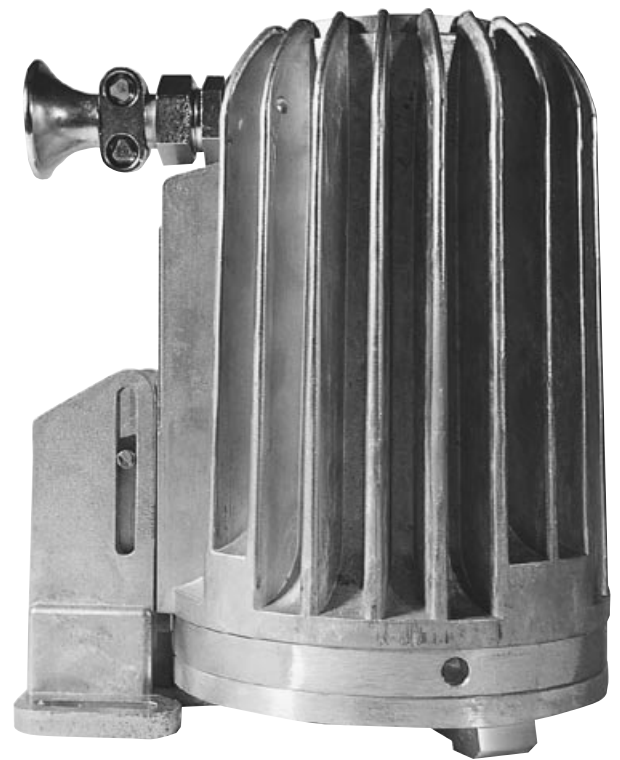
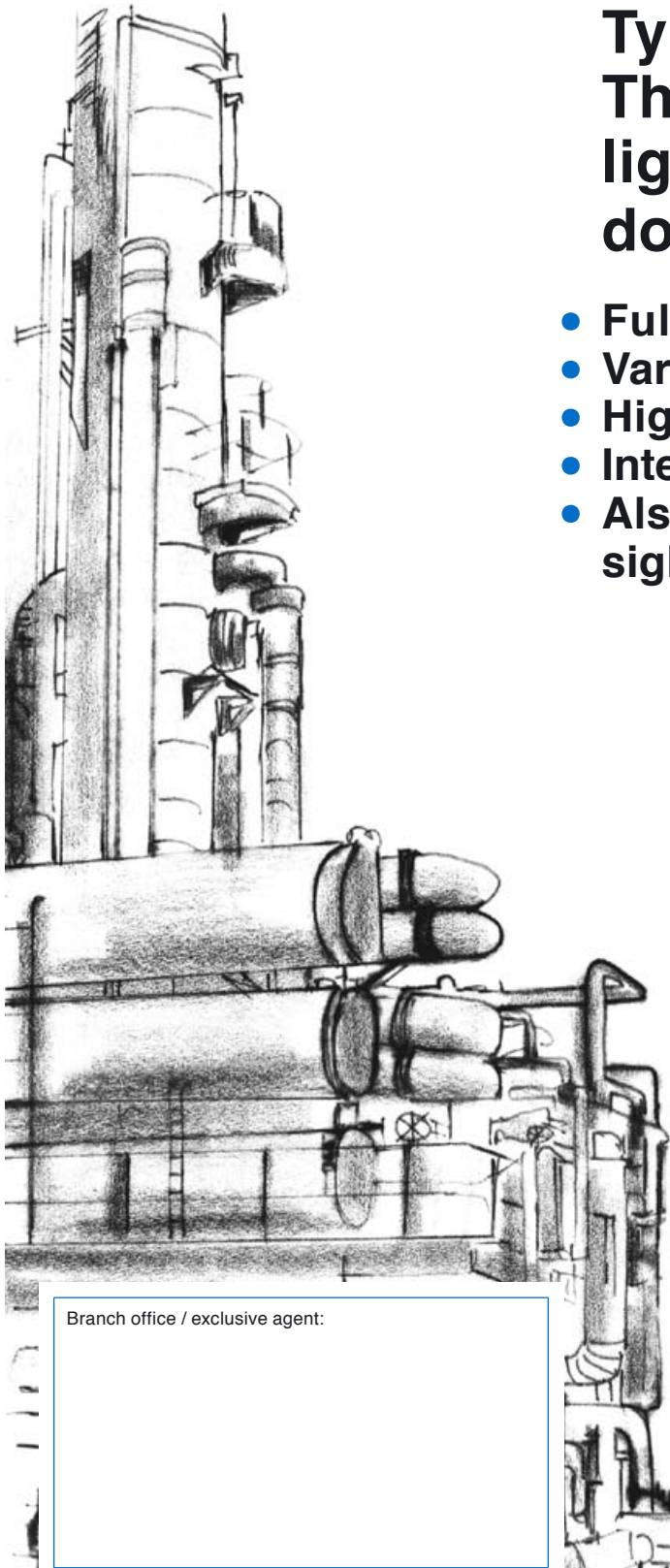

Type L 20 deH Sch sp, 20 W, 240 V, Ex d IIC T5, Ex tD A21
IP65 T95°C, Ex II 2 G + D, with tilting hinge fixation "Sch"

Branch office / exclusive agent:



Short information and advantages General technical data

For 30 years, the light fitting of the type L 20 deH has continuously been developed and adapted to maintain its position at the forefront of available technology. In addition to the well known MM quality and reliability, it offers due to an unrivalled range of fixation possibilities, together with an extensive range of options and accessories, the following advantages:

For the purchasing department:

- **Highly competitive prices** due to compact value-engineered design and efficient manufacturing techniques
- **Short lead times**

For the design or plant engineer:

- **Easy installation** with the availability of 4 fixation systems (tilting hinge "Sch", flange "F", footring "N", tension springs "Z"), covering all the requirements for applications on:
 - Circular sightglasses to DIN 28120 / 28121 or similar
 - Screwed sightglasses similar to DIN 11851
 - Sightflow indicators for pipelines
- Particularly designed for applications with vessels, reactors, agitated tanks and silos, producing **brilliant illumination**, even in difficult circumstances due to built-in highly polished reflector
- **Classified in T5 temperature class**
- Light unit may be **installed in any orientation without restriction**
- **Admitted** for use in food processing applications
- Available on request fitted **with transport handle "T₁"**, thus serving as a hand or portable lamp
- Available for use with different common terminal voltages (see on page 3)
- To be **equipped with energy saving electronic timers "V" / "U"**. The "V" version permits the operation of the light fitting **both on the unit and at a distance**, the "U" version at a distance only
- To be **equipped with a built-in device for momentary operation "D"**

For the maintenance electrician:

- **Quick and easy replacement** of bulbs
- Large junction box facilitates **easy connection**

For the safety officer:

- Certified to ATEX in the groups G (zones 1 and 2) and D (zones 21 and 22)
- **Available on request with built-in double action safety switch system, cutting the light fitting automatically from the supply source in case of bulb change**

Operating conditions: Completely **independent** of the vessel internal pressure or vacuum. There is **no restriction** on the mounting position of the light fitting.

Electrical data:

Supply:	AC or DC, depending on supply voltage (Note: With built-in transformer AC only)
Terminal voltages:	Please refer to table on page 3
Power:	20 W

Enclosure protection degree: **IP 65**



Construction and materials: The lamp housing and fixations are made from corrosion resistant cast aluminium alloy [Anticorodal, Mg <1%]. On request, and at extra charge, painted with a two component acrylic based paint finish "K". Cable gland M 20 x 1,5. Connection at terminals for wires up to 2,5 mm². In addition, an extra external 4 mm² earth terminal is provided. When timer "V" or "U" is fitted, a standard operating time of 3 minutes is programmed at our works, other time periods may be specified at the time of ordering. With built-in transformer, the light fitting contains an integrated fuse. Sockets: BA 15 d or G4.

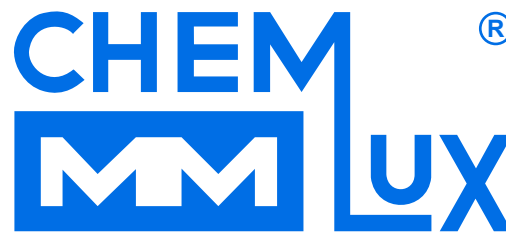

Technical data Accessories Mounting options

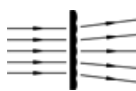

Designation		L 20 deH
Nominal rating	(W)	20
Terminal voltage with built-in transformer	(V)	24, 36, 42, 115, 230, 240
Secondary voltage of built-in transformer	(V)	12
Bulb		Halogen
Socket		BA 15 d or G4
Weight *	(kg)	4,55
Ignition protection type to	EN 60079-0 / 60079-1 / 60079-7 EN 61241-0 / 61241-1	Ex de Ex tD A21 IP65
Explosion group		II C
Temperature class G / D	T _a = - 20°C / + 40°C (T _a up to + 60°C on request)	T5 / T95°C
ATEX		Ex II 2 G + D

* Only light fitting. Fixations: "Sch": 0,3 kg, "Z": 0,27 kg, "F": 0,55 kg, "N" depending on DN

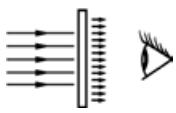
	Vibration absorbers (silent blocks) ... G Vibrations from the surrounding plant can have a deleterious effect on the life even of halogen bulbs. Vibration absorbers made from chemically and thermally resistant silicone are offered for use with the tension spring fixation ...Z.
	Transport handle ... T ₁ This ergonomic and insulated handle makes transport around the plant easy, and also facilitates the use of the light fitting for inspection inside a vessel on a trailing lead.
	Paint finish ... K The special two component acrylic paint finish protects against corrosion in excessively aggressive environments, and may satisfy customers special aesthetic requirements.
	Flood reflector ... FI For certain applications, a higher dispersion of the light beam as compared to that of the standard models may be desired. In that cases, a flood reflector-bulb unit which may be installed also at a later stage, is provided.

	Opal glass screen ... M In some cases, such as in pipeline flow indicator applications, a strong blinding effect occurs. For such situations we offer an opalised glass screen fitted into the unit, which increases the dispersion of the light and eliminates glare.
	Device for momentary operation ... D In order to cut down on wasted energy and improve the bulb life, the light fitting may be equipped with a built-in device providing momentary illumination. This device cannot be combined with either timer "V" or "U". (Please refer to our leaflet "switches, push-buttons and timers").
	Timers ... V / U The timers for operation on the unit or at a distance ...V or at distance only ...U save energy and increase the lifetime of the bulb by limiting operation to approximately 3 minutes. They are particularly recommended for short or sporadic observation of the vessel contents. The timers cannot be combined with the device ...D. (Please refer to our leaflet "switches, push-buttons and timers").

Mounting possibilities:

- On sightglasses to or similar to DIN 28120 / 28121: See table right
- On screwed ("dairy") type sightglasses similar to DIN 11851:
On special grooved collar nuts. (On enquiry please state the nominal diameter [DN]).
(**Only** with fixation "N").
- On sightflow indicators:
With the tilting hinge fixation "Sch", the footing fixation "N" or with specific adaptation by the customer.

Nominal diameter (DN)	50	80	100	125	150	200
Sightglass to DIN 28120 (A)	A	A	A	A	A	A
Sightglass to DIN 28121 (B)	B	B	B	B	B	B
Fixation						
... N	•	•	•	•		
... Z			•	•	•	
... Sch			•	•	•	•



CHEMLUX[®] sightglass light fitting, type L 20 dH Sch, 20 W, 230 V, Ex de IIC T5, Ex tD A21 IP65 T95°C, Ex II 2 G + D, with fixation "Sch" on a basket centrifuge

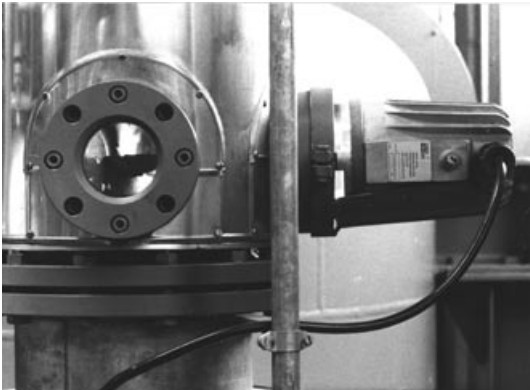

CHEMLUX[®] sightglass light fitting, type L 20 deHsp, 20 W, 240 V, Ex de IIC T5, Ex tD A21 IP65 T95°C, Ex II 2 G + D, mounted on top of a distillation column



CHEMLUX[®] sightglass light fitting, type L 20 deH M sp, 20 W, 24 V, Ex de IIC T5, Ex tD A21 IP65 T95°C, Ex II 2 G + D, mounted with an opal glass screen "M" on a pipeline flow indicator

All dimensions in mm.

Subject to changes without preliminary notice.

Tension spring fixation ... Z

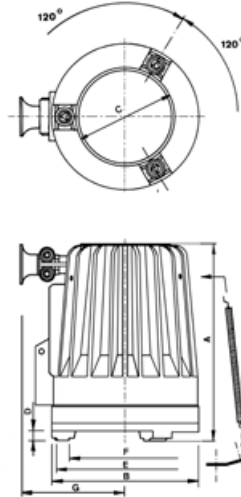

A	B	C	D	E	F	G
218	145	95	11	139	115	122

Flange fixation ... F

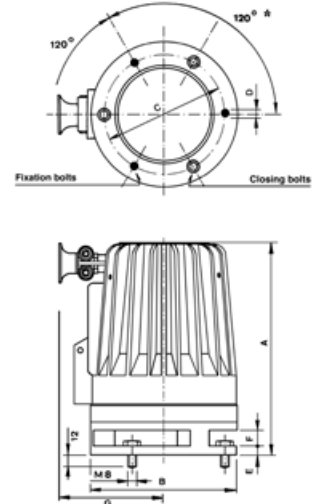

A	B	C	D	E	F	G
232	145	115	8,5	9	16	122

* Other non-standard flanges on request

Tilting hinge fixation ... Sch

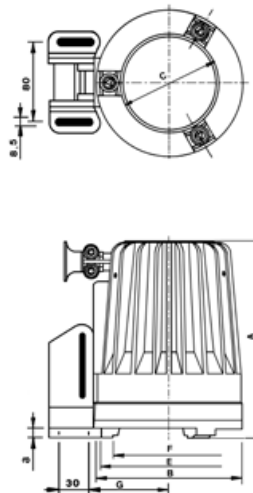

A	B	C	D	E	F	G
218	145	95	3	139	115	75

Foot ring fixation ... N

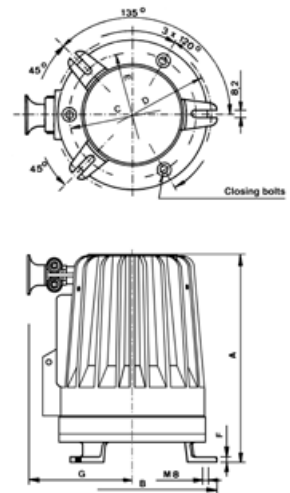

A	B	C	D	E	F	G
241	165	120	155	135	6	122

Non-standard fixation systems on request

Do you wish for more information about our wide range of light fittings for use in hazardous and safe areas, about our range of circular sightglasses to DIN 28120/28121, screwed sightglasses similar to DIN 11851, rectangular or D-ended sightglasses, pipeline flow indicators, centrally or sideways operated wipers, hinged sightglasses, spraying devices or our complete sight and lightglass units VETROLUX[®]? Are you interested in other types, special versions or different protection degrees? If yes, please contact us, our branch office or our local agents – it is our business! You will find the necessary indications about our sales network on the Internet.